



Technical Conservation Group

Technical Paper 1

Thermal performance of traditional windows

Prepared for Historic Scotland

with corrections
and clarifications
September 2010



Dr. Paul Baker (Centre for Research on Indoor Climate & Health,
Glasgow Caledonian University)
October 2008

Historic Scotland Technical Paper 1
Corrections and clarifications
September 2010

Corrections

Page 17, Table 6: The *in situ* U-value from Lauriston Place for single glazing with secondary glazing has actually been 1.6 W/m²K instead of 2.3 W/m²K.

Clarifications

The U-values in this report are measured at the centre of the glass pane, and are not whole-window U-values; except for the U-value measured by the National Physical Laboratory, refer to Appendix 1, which is a whole-window U-value.

The double glazing tested in the laboratory has been a slim-profile double-glazed unit, in which the cavity was filled with a krypton-xenon mix.

Technical Paper 1

Thermal Performance of Traditional Windows



Improving the thermal performance of traditional windows

**Prepared for Historic Scotland by
Paul Baker
Glasgow Caledonian University
October 2008**

Summary of report by Paul Baker, Glasgow Caledonian University.

The Scottish Government has set a target of reducing Scotland's carbon emissions by 80% by the year 2050. This is an ambitious target that requires a series of energy saving measures to be implemented across the country. Just under one fifth of Scotland's dwellings are traditionally constructed, and have significant value to Scotland's built heritage. The key issues for these buildings is how to make them energy efficient, in a way that does not detract from their character or damage the building fabric.

To tackle this question, Historic Scotland's Technical Conservation Group commissioned the Centre for Research on Indoor Climate & Health at Glasgow Caledonian University to carry out a series of tests on traditional window performance. Windows are the most targeted building element for replacement to reduce heat loss in dwellings. The window that was tested, provided by Historic Scotland, was a typical timber single paned sash and casement window.

The thermal performance of the window was tested at the National Physical Laboratory using a guarded hot box system, in order to get an industry-standard measurement of the window's properties. The thermal transmittance of the window (known as the U value) was measured as being 4.5 W/m²K.

Draught proofing is a common practice to prevent wind from blowing in through traditional windows. The test window was draught proofed, and although the U value of the window was not improved, the airtightness of the window was improved considerably, reducing the air leakage by 86%. The window is tighter than the recommended 4,000 mm² trickle vent for domestic new build.

A series of heat loss reduction measures were tested. These measures are all standard steps that people can take and are widely available, including the use of curtains, shutters, blinds, and secondary glazing. All the options were tested on the window in the Environmental Chamber at Glasgow Caledonian University, and all were shown to reduce the heat loss through the glazing to varying degrees.

Secondary glazing was the most effective overall option, as it reduced heat loss through the window by 63%. Timber shutters are the most effective option of the traditional methods, reducing heat loss by 51%; curtains reduced heat loss by 14%; a Victorian roller blind reduced heat loss by 28%; a modern roller blind reduced heat loss by 22%. The greatest reductions in heat loss came from combining these measures (i.e. blinds, shutters and curtains all closed) and by adding extra insulation to these options. Using secondary glazing, or combinations of blind and shutters, reduced the U value of the window to below 2 W/m²K, which is the maximum U value allowed by Scottish Building Standards for timber or uPVC windows in new dwellings with an energy efficient boiler.

The comfort of a room is affected by the temperature of the surface of the window area. When the surface temperature of the window area is higher, thermal comfort is improved. All the options tested offer improved thermal comfort compared with single glazing alone.

This report clearly demonstrates the effectiveness of various options for reducing heat loss through windows. Clearly there are some other considerations to take in to account; for instance, some measures cut out light altogether, and so can only be used at night. Some measures are more expensive than others, which is another major consideration for homeowners. This report allows people to make measured judgements regarding how they can reduce Scotland's carbon emissions, and their fuel bills, without taking away the character of traditional buildings.

The Thermal Performance of Traditional Windows

1. Introduction

This report summarises the results of research on the thermal performance of traditional windows and methods of reducing heat loss carried out by the Centre for Research on Indoor Climate & Health, Glasgow Caledonian University (GCU) on behalf of Historic Scotland. Whilst most of the work was laboratory based using a sash and case window, some *in situ* measurements were carried out in a tenement in Edinburgh. Historic Scotland carried out a series of thermographic surveys to complement the thermal performance tests. The results of the surveys are appended to this report.

2. Context

Figure 1 shows the distribution of the age of dwellings in Scotland from the Scottish House Condition Survey (SHCS) Key Findings for 2005/2006 [1].

Figure 1: Age of Dwelling (Scottish House Condition Survey Key Findings for 2005/6)

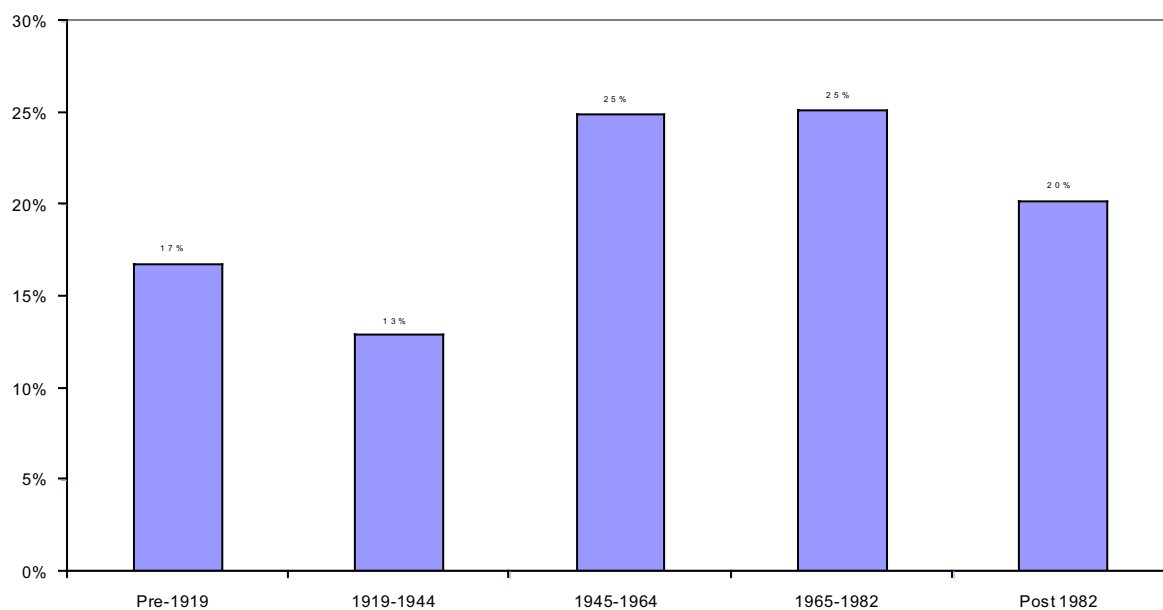

The 2002 SHCS [2] found that the energy efficiency of the housing stock as a whole has improved significantly since the 1996 survey (e.g. over 90% of homes have full or partial central heating, 88% have some form of loft insulation and 87% have double glazing). Table 1 shows the proportion of dwellings by age with double glazing [3]. Pre-1919 dwellings have the lowest proportion of double glazing.

Table 1: The proportion of dwellings by age with double glazing

Age of dwelling	Percentage of dwellings with double glazing
Pre-1919	63%
1919-1944	87%
1945-1964	90%
1965-1982	93%
post 1982	97%

The survey uses the National Home Energy Rating (NHER) [4] to measure energy efficiency. Table 2 shows the number of homes rated as 'poor', 'moderate' or 'good' for each dwelling age category as a percentage of the total housing stock based on the 2005/2006 SHCS report [1].

Table 2: National Home Energy Ratings of Scottish housing stock by age as a percentage of the total housing stock

	NHER band		
	Poor	Moderate	Good
	%	%	%
Pre-1919	2.4%	10.6%	3.9%
1919-1944	0.5%	7.5%	4.9%
1945-1964	0.7%	13.0%	11.2%
1965-1982	0.5%	12.6%	12.1%
Post 1982	0.0%	5.1%	15.2%
TOTAL	4.1%	48.6%	47.2%

Thus some 53% of dwellings in Scotland may be considered to have less than good energy efficiency. Whilst pre-1919 dwellings are the largest proportion of the poorly rated dwellings at 2.4% of the total stock, the proportion of pre-1919 dwelling which have a less than good rating is similar to homes built between 1945 and 1982.

Effecting improvement of the housing stock in response to climate change and reducing CO₂ emissions, whilst maintaining our architectural heritage, presents a challenge. The options for upgrading the thermal performance are particularly limited for pre-1919 dwellings with solid wall constructions. Traditional single glazed windows are considered as perhaps the easiest option for replacement with modern double glazing. Traditional windows are often considered to be draughty, prone to condensation and hard to maintain. On the other hand, with good maintenance traditional windows may outlast modern replacements and may be considered as a sustainable resource. However, the heat lost through a single glazed window is about double that through a double glazed window meeting the current Scottish Building Standards (maximum U-value of 1.8 W/m²K for a timber or PVC-u window in a dwelling with an energy efficient central heating boiler). Whilst secondary glazing may be effective as an option to preserve existing traditional windows, there is little information on the performance of more traditional (and cheaper) methods of reducing heat loss, such as shutters, blinds and curtains.



Figure 2: Historic Scotland sash and case window



Figure 3: Curtains



Figure 4: Shutters

3. Laboratory Studies

The main objective of the laboratory investigations was to determine the benefits of using methods such as the addition of shutters, blinds and curtains on the reduction of heat loss through the glazing of a traditional sash and case window, measured using heat flux sensors in the Environmental Chamber at GCU. Historic Scotland also carried out thermal imaging studies of the various options; the results of which will be published separately. The improvement in airtightness of the window after draught-proofing by Ventrolla Ltd. was determined by pressurisation testing. The thermal transmittance (U-value) of the window was also measured by the National Physical Laboratory (NPL) by the guarded hot box method [5,6] before and after draught-proofing.

3.1 The Test Window and Options

Historic Scotland provided a 6 x 6 sash and case test window (Figure 2). The maximum window dimensions are 1885mm (h) × 1065mm (w) × 165mm (d). Each pane is approximately 270mm (h) × 245mm (w).

As received, the window was in good condition, but without draught proofing. Following thermal transmission testing at NPL, the window was professionally draught-proofed by Ventrolla Ltd. The draught proofed window was the focus of the main series of thermal performance tests carried out in the GCU Environmental Chamber.

The test options examined in the GCU environmental chamber were as follows:

- Option 1.** Heavy curtains fitted to rail on inside of insulated panel above window (Figure 3).
- Option 2.** Shutters (Figure 4)
- Option 3.** Modified shutters, with Spacetherm [7] insulation blanket of 9mm thickness inserted into panels and covered with 6mm plywood as shown in Figure 5 and installed in Figure 6. The insulated area of the shutters is 55%. Spacetherm is an aerogel insulation with a manufacturer's quoted thermal conductivity of 0.013 W/mK.
- Option 4.** Modern roller blind fitted at the top of the window case inner lining (Figure 7).
- Option 5.** Modern roller blind as option 4, with low emissivity plastic film fixed to the window facing side of the blind (Figure 8).
- Option 6.** Victorian blind fitted to the top of the recess formed by the window case pulley stiles at the side of the upper sash (Figure 9).
- Option 7.** A "thermal" Duette honeycomb blind manufactured by Hunter Douglas Europe b.v. (Figure 10).



Figure 5: Insulating shutter panels



Figure 6: Insulating shutters installed



Figure 7: Modern roller blind



Figure 8: Low-e film on roller blind



Figure 9: Victoria blind



Figure 10: Honeycomb blind

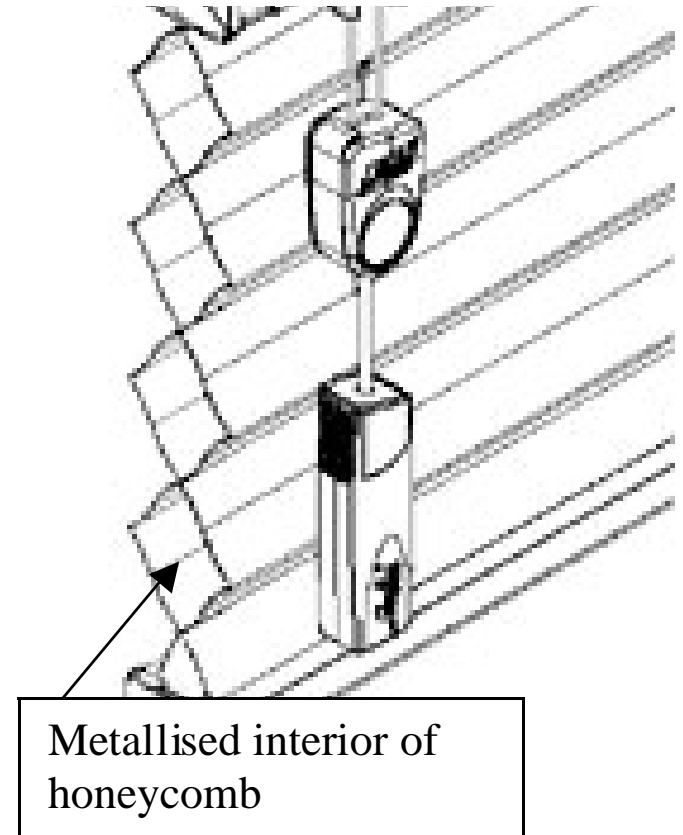

Combinations of the curtains, shutters and Victorian blind were also tested.

Care was taken to fit each option reasonably tightly to the window.

Following these tests a secondary glazing system (Figure 11) manufactured by Storm Windows was fitted and tested. The glazing used is low emissivity. The system was mounted within the 'staff beads' of the sash window. With the secondary glazing in position the effects of curtains and shutters were determined.



Figure 11: Secondary glazing system

The secondary glazing was removed and the window re-glazed with Slimlite low emissivity double glazed panes, manufactured and installed by Fountainbridge Windows Ltd., Edinburgh.

3.2 NPL Thermal Transmittance Tests

Thermal transmittance tests were carried out on the window in the NPL guarded hot box before and after draught proofing. The test reports are appended in Appendices 1 and 2. The results are given in Table 3.

Table 3: NPL guarded hot box results for the sash and case window before and after draught proofing.

	Standardised thermal transmittance U-value) W/m ² K
Before draught proofing	4.5
After draught proofing	4.2

The difference in the U-values is not statistically significantly different since the overall measurement uncertainty is $\pm 5.5\%$. The average value is 4.4 W/m²K.

Whilst the glazed area is 55% of the total window area, approximately 72% of the heat is lost through the glazing assuming an indicative centre of pane glazing U-value of 5.7 W/m²K as given in CIBSE Guide A [8].

3.3 Thermal Performance Tests in the Environmental Chamber

3.3.1 Test Procedure

The test window was installed in a 300mm thick insulated panel mounted between the two rooms of the GCU Environmental Chamber (Figure 2), with the window frame set flush with the cold face of the panel as recommended by BS EN ISO 12567-1:2000 [6]. Silicone sealant was used around the joints between the window and the insulated panel in order to seal all gaps and hold the window firmly in position.

The Environmental Chamber (Figure 12) is designed to test the performance of building materials & components under the range of climate conditions experienced in the UK. The chamber consists of two walk-in rooms, an “Exterior” room which can be used to simulated outdoor weather and an “Interior” room to simulate typical indoor environmental conditions. The exterior room also has the facilities to simulate driving rain and solar radiation (using infra-red lamps) on a wall surface. Both rooms can be pressurised. The aperture formed between the rooms can accommodate a wall up to 3m wide by 2.4m high. By moving the interior room different wall thicknesses can be constructed. The two rooms can be controlled within the temperature and humidity ranges as shown in Table 4. The temperature and humidity in both rooms and the driving rainfall and infra-red lamps are fully controllable from either built-in controllers or a PC.



Figure 12: The GCU Environmental Chamber

Table 4: Temperature and humidity ranges for GCU Environmental Chamber

	Temperature and humidity ranges:	
	Temperature	Relative Humidity
Exterior room:	-20°C to + 30°C	20% to 90%*
Interior room:	+10°C to + 40°C	20% to 90%*

*Note: relative humidity is not controlled if the set point temperature is below 10oC.

The whole window U-value can not be measured in the test facility (an accurate hot box facility is required, e.g. NPL guarded hot box). However, since the main heat loss is through the glazing, heat flux meters mounted on the glazing can be used to determine this directly, and with surface temperature measurements, the centre of pane U-value can be estimated for the glazing alone and with the addition of the various options. Hukseflux Type HFP01 heat flux sensors were used (Figure 13) affixed to the glass with double sided adhesive tape. The sensors have a quoted manufacturer's thermal resistance of less than $6.25 \times 10^{-3} \text{ m}^2\text{K/W}$.

Air temperatures in both the interior (warm) and exterior (cold) rooms, the surface temperatures of the glazing and the surface of curtains, shutters and blinds were measured with type-T thermocouples. Glazing surface

thermocouples were affixed to the glass with transparent tape. All sensors were logged at 1 minute intervals and stored as 10 minute averages using a Delta-T Devices Ltd. Deltalogger.

Test conditions generally used were 2°C in the exterior room and 22°C in the interior room. To avoid condensation the relative humidity in the interior room was set at 30%. Generally, tests were run for a sufficient duration to allow the environmental conditions in the test rooms and the heat flow through the window to stabilise after the installation of each option, and then collect at least two to three days data for analysis; for example Figure 14 shows data for a test with a heavy curtain.

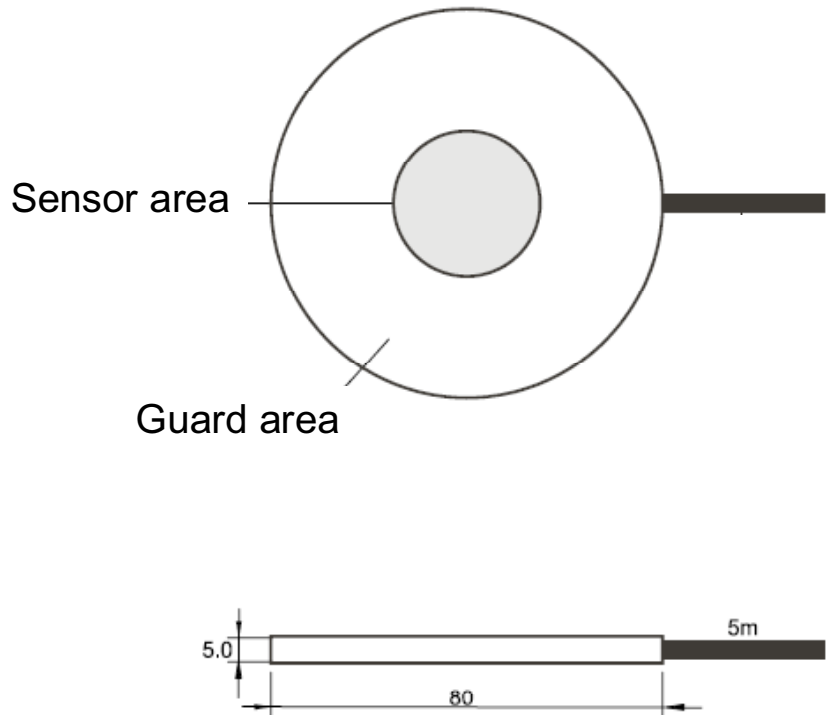

Figure 13: Heat flux sensor in position on glazing and sensor dimensions

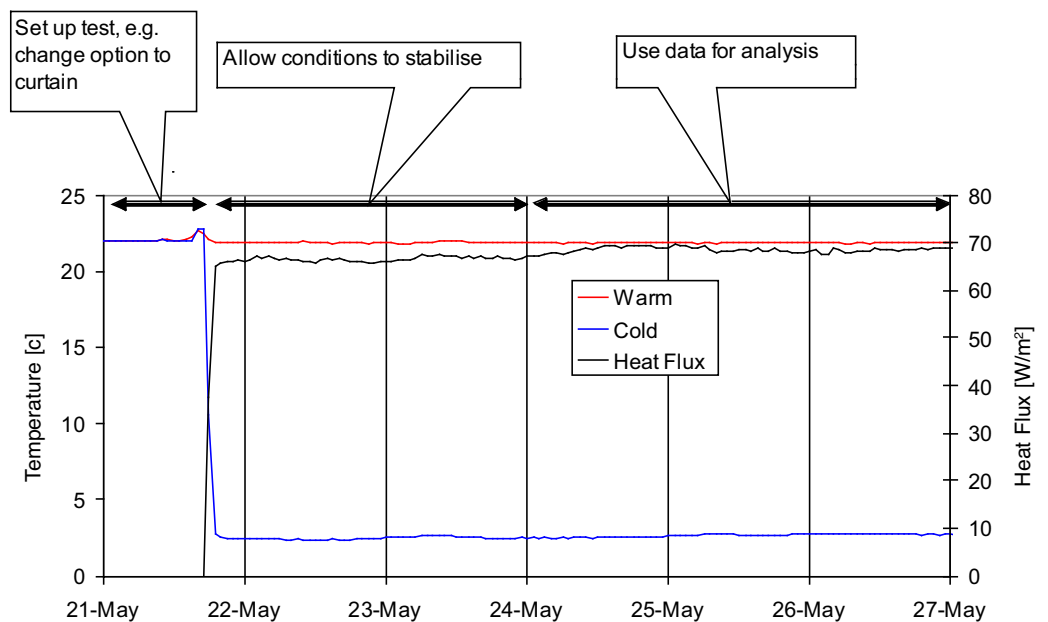

Figure 14: Example of test showing warm and cold room temperatures and heat flux through glazing.

3.3.2 Analysis

The effect of the various options on the heat loss through the glazing was estimated as follows:

For each option, the heat flow through the glazing was compared with that measured during the test on the single glazing only. The percentage reduction in heat loss was calculated with an adjustment for the variation in the chamber air temperatures between the tests.

A U-value (Equation 1) was calculated from the average heat flux meter reading and surface temperature difference between the outer glazing surface and the room facing surface of each option with a correction for the standardised internal and external surface resistances and the thermal resistance of the heat flux meter:

$$U = \frac{1}{\left(\frac{T_{si} - T_{se}}{Q}\right) + 0.17 - 6.25 \times 10^{-3}} \text{ W/m}^2\text{K} \quad \text{Equation 1}$$

where T_{si} and T_{se} are respectively the internal and external surface temperatures, and Q is the heat flux. The term 0.17 is the sum of the standard internal and external surface resistances. 6.25×10^{-3} is the correction for the heat flux meter.

This approach is justified because the boundary conditions in both rooms of the chamber are unknown and would require extensive calibration outside the scope of this investigation. However, steps were taken to reduce excessive air movement in both rooms by baffling of the air conditioning system. Without baffling it was observed that the heat flux increased, and calculating the glazing U-value from the heat flux divided and the air temperature difference gave unreasonably high results.

Moreover, the temperature of the surface of the curtain, shutter or blind facing the interior (warm) room is reported for comparison with the glazing temperature of the window without the option. This gives an indication of the improved comfort that should be experienced with a better insulated window.

3.3.3 Results

The test results are shown in Table 5 and compared in Figures 15 and 16. The estimated uncertainty of the U-values is $0.3 \text{ W/m}^2\text{K}$; this is largely due to temperature stratification down the window. For example, during the testing of the foil-backed roller blind (Option 5) the average temperature of the inside surface of the top pane is 9.6°C compared with 6.6°C for the bottom pane. The stratification is confirmed by the Historic Scotland thermographic survey [9].

All the measures have some impact on reducing the heat flow through the glazing. Of the options tried before secondary glazing, the most effective traditional solution is the shutters showing a 51% reduction in heat loss. Figure 17 shows the effect of closing the shutters on reducing heat flow through the glazing. Insulating the panels of the shutters produces a significant improvement of 60% and a U-value equivalent to low emissivity double glazing.

Additional heat flux measurements on the surface of the middle insulated panel indicate that further reductions in heat loss are possible, as high as 80% equivalent to a U-value of $0.7 \text{ W/m}^2\text{K}$ if the insulated area of the shutter was maximised, e.g. by manufacturing a properly designed shutter.

The modern roller blind with the low emissivity foil is almost effective as the

shutters. Whilst not as effective, the honeycomb blind may offer a more aesthetic appearance.

The combinations of blind, shutters and curtains give U-values similar to the insulated shutter.

Table 5: The effect of the various options on reduction in heat loss through single glazing, the estimated

U-values and measured average surface temperatures

	Reduction in heat loss	U-value W/m ² K	Temperature of Interior (warm) room facing surface °C
Centre of glazing	-	5.4	12
Option 1. Heavy curtains fitted to rail on inside of insulated panel above window	14%	3.2	20
Option 2. Shutters	51%	2.2	19
Option 3. Modified shutters, with insulation inserted into panels and covered with 6mm plywood	60%	1.6	21
Option 4. Modern roller blind fitted at the top of the window case inner lining	22%	3.0	21
Option 5. Modern roller blind as option 4, with low emissivity plastic film fixed to the window facing side of the blind	45%	2.2	20
Option 6. Victorian blind fitted to the top of the recess formed by the window case pulley stiles at the side of the upper sash	28%	3.2	18
Option 7. A “thermal” Duette honeycomb blind manufactured by Hunter Douglas Europe b.v.	36%	2.4	21
Victorian Blind & Shutters	58%	1.8	19
Victorian Blind, Shutters & Curtains	62%	1.6	21
Secondary Glazing System	63%	1.7	19
Secondary Glazing & Curtains	66%	1.3	22
Secondary Glazing & Insulated Shutters	77%	1.0	21
Secondary Glazing & Shutters	75%	1.1	20
Double Glazing	55%	1.9	18

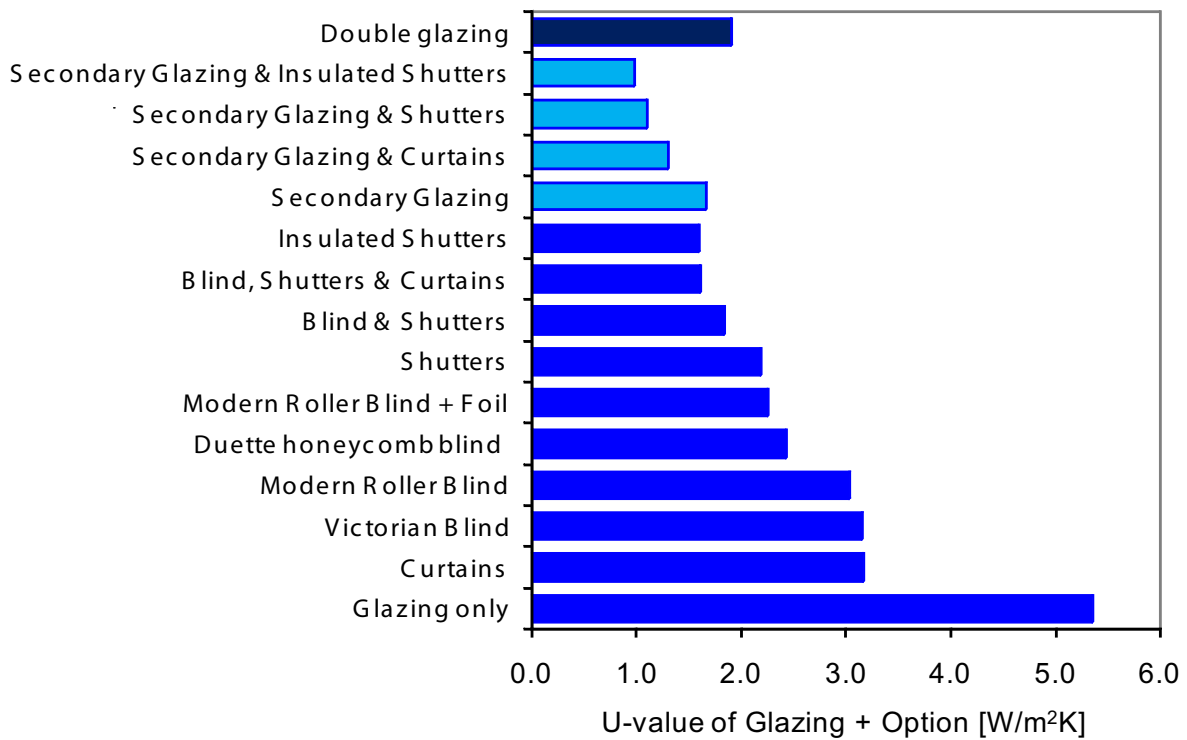

Figure 15: Effect of the options on U-value



Figure 16: Effect of the options on reduction in heat loss through the glazing

Installing the secondary glazing clearly gives an improvement which is comparable to the best of the options examined prior to its installation, however the secondary glazing has the advantage that its benefits can be realised both day and night. Augmenting the secondary glazing with the other options gives further improvement, however the insulated shutters give only a small improvement over the original (un-insulated) shutters.

Replacing the single glazing with the Slimlite double glazed panes also produces a significant improvement.

Effect of Closing Shutters

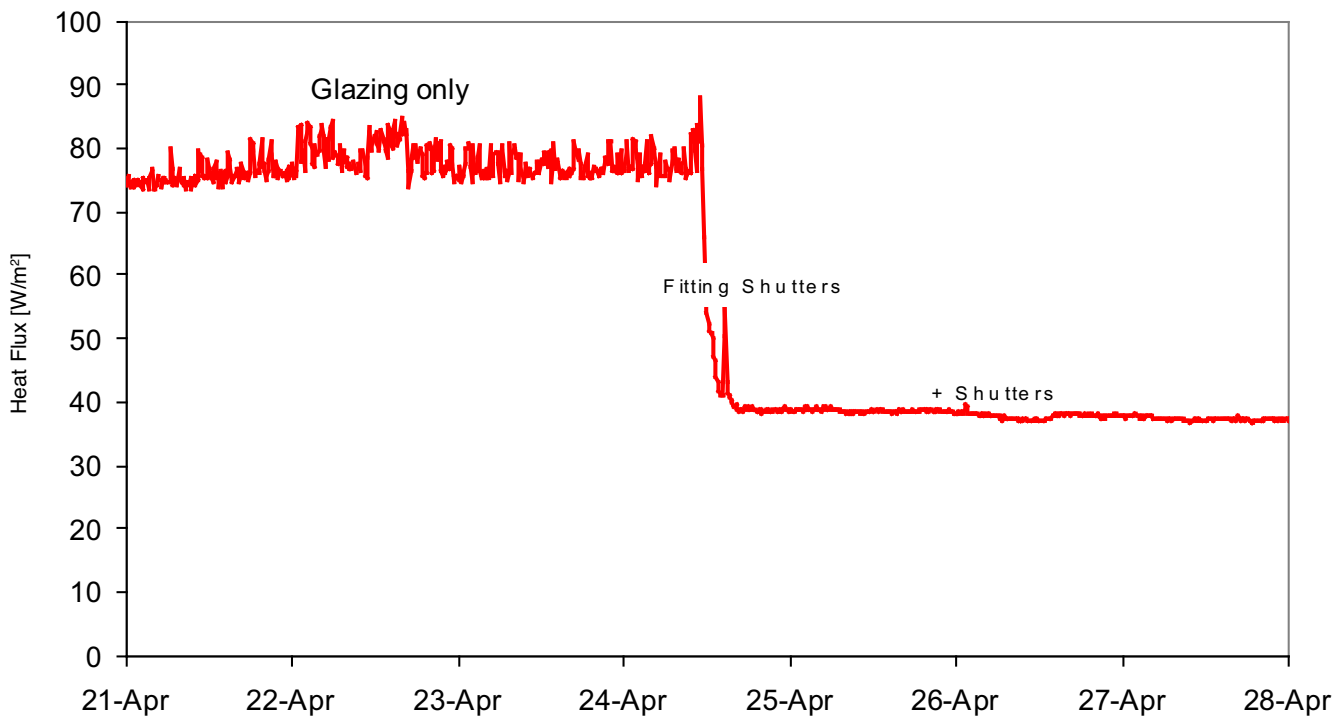

Figure 17: The effect of closing shutters.

3.4 Airtightness tests

The airtightness of the window (1) before and after draught proofing and (2) after installation of secondary glazing was measured by a pressurisation method with both test rooms at 22°C. Figure 18 shows the basic principle of the test.

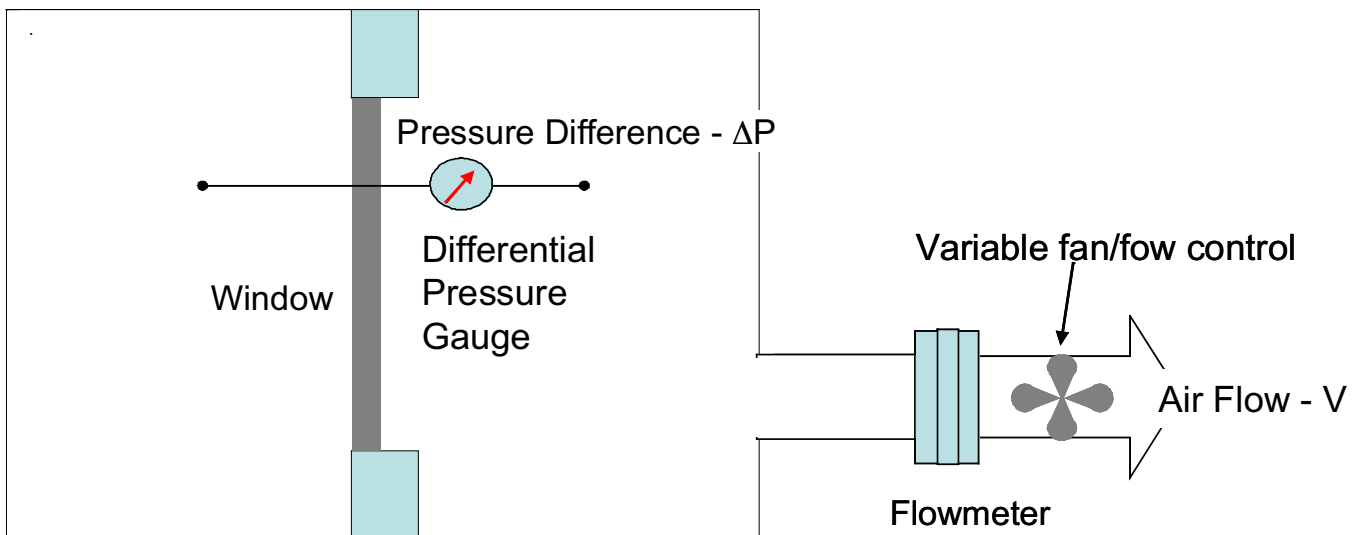

Figure 18: Pressurisation test – the air flow (V) is adjusted to produce a pressure difference (ΔP). This procedure is repeated to produce a range of values, usually up to and including 50 Pa pressure difference.



The test is carried out in two parts, (i) with the window covered by an air impermeable polythene sheet, which is taped to surrounding panel (Figure 19), to determine the background air leakage of the test room and (ii) without the window covered to determine the total air leakage of the room and window at each pressure difference. The background leakage at each pressure difference is subtracted from the total leakage to estimate the window leakage.

The results are plotted and a power law relationship is usually fitted to the data. The results for the test window before and after draught proofing are shown in Figure 20.

Figure 19: The window covered with air impermeable polythene sheet to determine background air leakage of room.

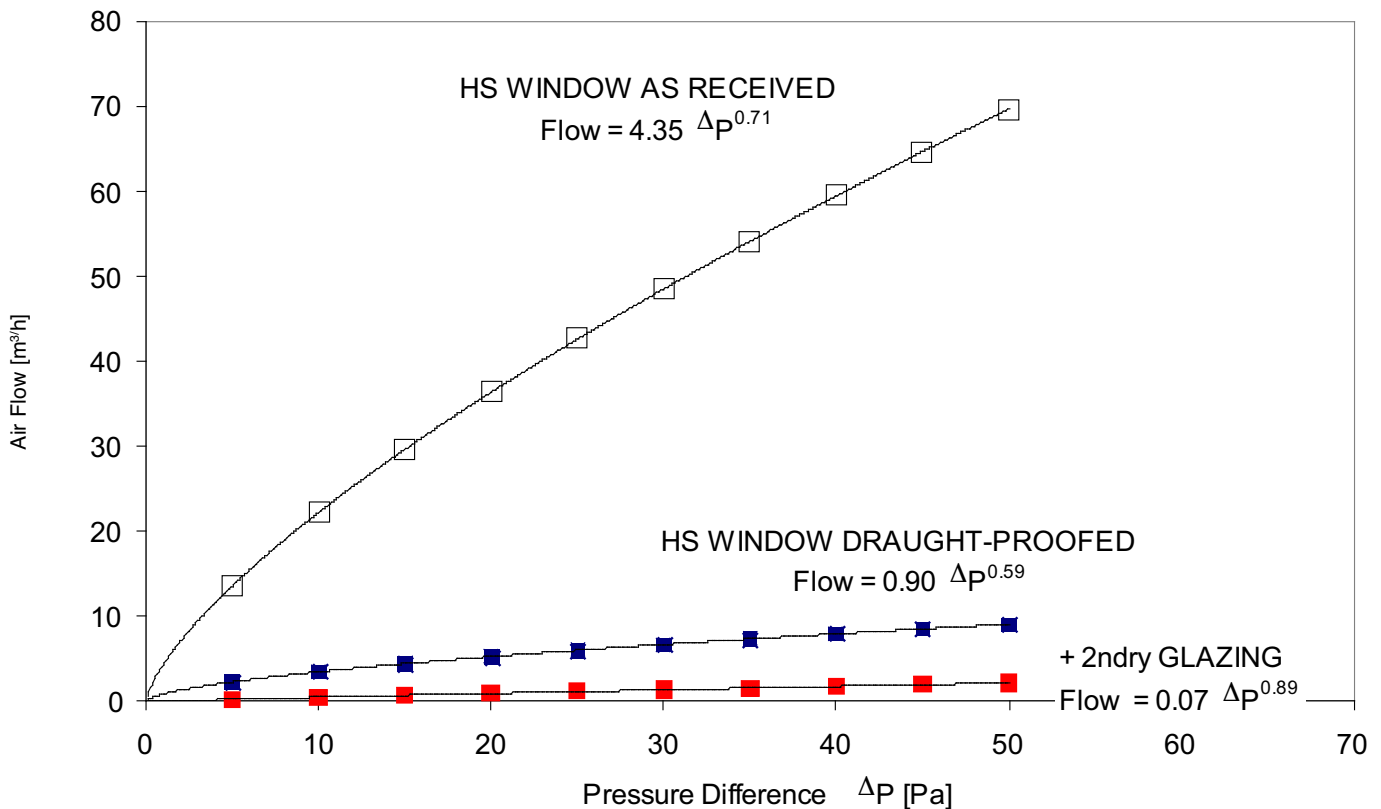

Figure 20: Air leakage characteristics of the test window before and after draught proofing by Ventrolla and after fitting of secondary glazing



Figure 21: Heat flux sensor mounted on glazing of window in offices of Lister Housing Co-op, Lauriston Place, Edinburgh

Over the range of pressure differences, the draught proofed window shows an 86% reduction in air leakage compared with the as-received condition. In order to give an estimate of the air leakage of the window under normal conditions it is common to express the leakage as the air flow rate at 50 Pa divided by 20 (N50/20). Before draught proofing this value is 3.5 m³/h and after 0.5 m³/h. A Canadian study [9] measured the air leakage characteristics of trickle vent with an area of 4000mm² as recommended in Section 3.14 of the Scottish Building Standards 2007 [10] for use in kitchens, bathrooms, toilets & utility rooms. The N50/20 value, 2.3 m³/h, is somewhat higher than the draught proofed sash and case window.

The carefully sealed secondary glazing system provides a further reduction in air leakage (97% compared to the as-received condition) with a N50/20 value of 0.1 m³/h. Since the lower sash of the secondary glazing system can be raised, it is possible to ventilate through the window when required.

4. In Situ Measurements

In situ U-value measurements were made during winter 2007/08 on the glazing of windows in Georgian apartments/offices in Lauriston Place, Edinburgh owned by the Lister Housing Co-operative, in order to assess the effect of secondary glazing (with low emissivity glazing) and shutters.

The basic methodology is the same as the thermal performance tests carried out in the GCU environmental chamber: a heat flux meter and surface temperature sensors were mounted on the glazing. External and room temperatures were also measured. However, since the conditions are not stable as for the laboratory studies, a longer monitoring period is required, usually at least two weeks, to obtain satisfactory results. One of the windows is shown in Figure 21. The occupants of the apartment with shutters were asked to open and close the shutters as normal practice. The results are given in Table 6.

Table 6: In situ results from Lauriston Place

	U-value W/m ² K
Single glazing only	5.5
Single glazing with secondary glazing	2.3 1.6
Single glazing with shutters	2.2

The effect of the shutters is similar to that found in the laboratory tests (Table 5). Figure 22 shows the effect of opening and closing the shutters on a typical day. Whilst the shutters are closed the heat loss through the window is reduced by about 70%.

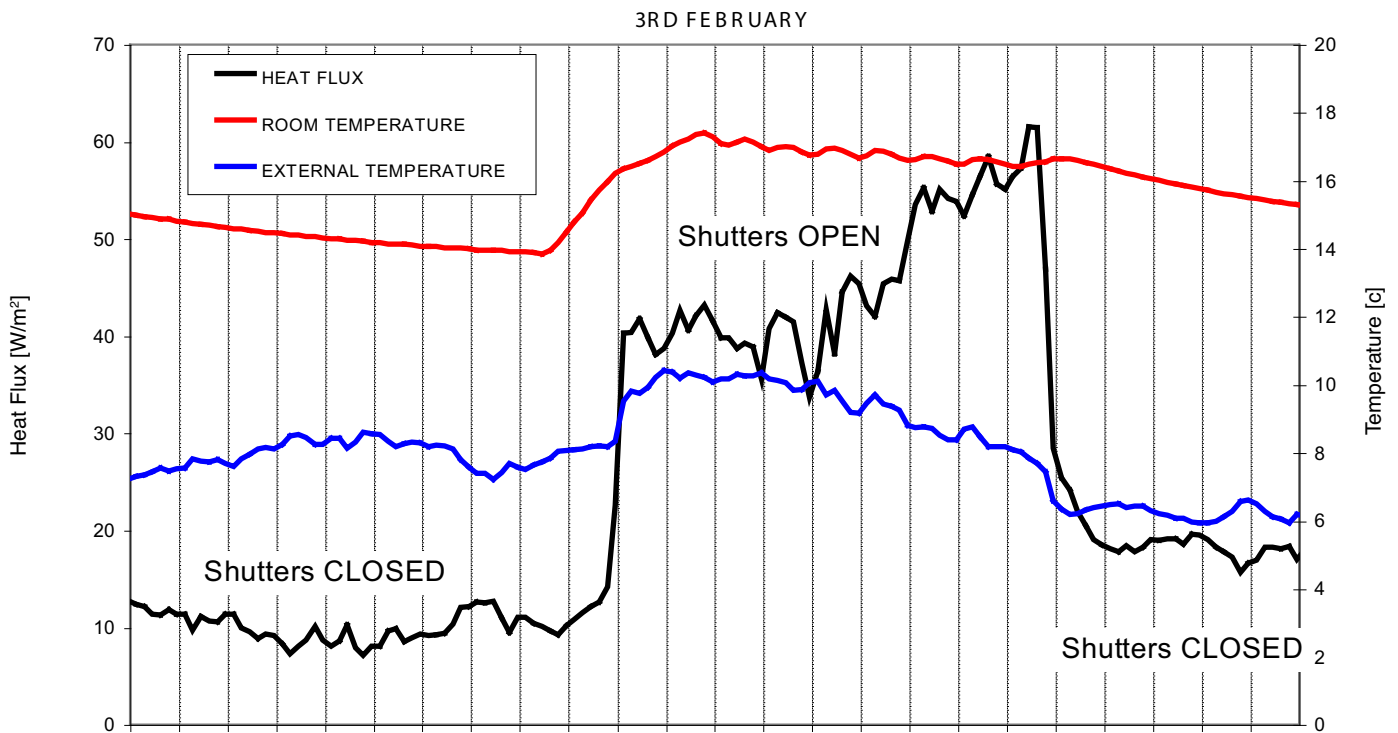

Figure 22: Effect of opening and closing shutters at Lauriston Place, Edinburgh

The secondary glazing gave a similar improvement, although not as high as expected from the laboratory test.

5 Conclusions

Measurements of the U-value of a traditional sash and casement window showed that there was no significant difference before and after draught proofing of the window. The whole window U-value is $4.4 \text{ W/m}^2\text{K}$. 72% of the heat loss through the window will be via the single glazing.

The airtightness of the window was improved considerably by draught proofing, reducing the air leakage by 86%. The window is tighter than the recommended 4000mm^2 trickle vent for domestic new build.

All the options tested in the GCU Environmental Chamber reduce the heat loss through the glazing. Shutters are the most effective option of the traditional methods, reducing heat flow by 51%. By insulating the shutters heat loss can be reduced by 60%. Further improvement would be possible with a purpose designed set of shutters. Improved blind designs also have the potential to reduce heat loss.

High performance secondary glazing and replacement double glazed panes offer improved thermal performance throughout the day. Careful installation of the secondary glazing also results in improved air-tightness.

All the options offer improved thermal comfort due to higher surface temperatures compared with single glazing alone.

The *in situ* U-value measurements confirm in practice the performance of traditional shutters and show the potential benefits of low emissivity glazing in a secondary glazing system.

6 References

- [1] Amabile D., Cairns P., Cormack D., Máté I. and Sloan A., Scottish House Condition Survey Key Findings for 2005/06, Housing and Regeneration Directorate, Scottish Government, ISBN 978 0 7559 6901 2 (web only publication: www.scotland.gov.uk/Publications/2007/12/07131524/0)
- [2] House Condition Surveys Team , Scottish House Condition Survey 2002, Communities Scotland, Scottish Executive, ISBN 1 874170 54 1
- [3] Glazing by Dwelling Age for Local Authority Areas, 2003-06, Scottish Government, www.scotland.gov.uk/Topics/Statistics/SHCS/glazing/Q/EditMode/on/ForceUpdate/on
- [4] The National Home Energy Rating scheme, www.nher.co.uk
- [5] BS EN ISO 8990:1996, Thermal insulation. Determination of steady-state thermal transmission properties. Calibrated and guarded hot box, BSI, ISBN 0 580 26826 8
- [6] BS EN ISO 12567-1:2000, Thermal performance of windows and doors. Determination of thermal transmittance by hot box method. Complete windows and doors, BSI, ISBN 0 580 36028 8
- [7] www.spacetherm.com/pdf/apg5738%20spacetherm%20v5.pdf
- [8] CIBSE Guide A: Environmental design, (7th Edition), The Chartered Institution of Building Services Engineers, London, 2006, ISBN-10: 1-903287-66-9
- [9] Karava P., Athienitis A., Stathopoulos T., Experimental investigation of the performance of trickle ventilators, Proceedings of 4th Annual Hybvent Conference, Concordia University, Montreal, Canada, May 2002.
- [10] Scottish Building Standards Domestic Handbook 2007, www.sbsa.gov.uk/tech_handbooks/tbooks2007.htm

Appendix 1

NPL Test Report on U-value of sash and casement window before draught proofing



NATIONAL PHYSICAL LABORATORY
Teddington Middlesex UK TW11 0LW Telephone +44 20 8977 3222



Test Report

THERMAL TRANSMITTANCE OF A
Traditional wood sash & casement window - as received

This test report is issued in accordance with the laboratory accreditation requirements of the United Kingdom Accreditation Service. It provides traceability of measurement to recognised national standards, and to units of measurement realised at the National Physical Laboratory or other recognised national standards laboratories. This test report may not be reproduced other than in full, except with the prior written approval of the issuing laboratory.

FOR Glasgow Caledonian University
Centre for Research on Indoor Climate & Health
School of Built & Natural Environment
Glasgow Caledonian University
City Campus
Cowcaddens Road
Glasgow
G4 0BA

For the attention of Paul Baker

IDENTIFICATION CSM-4(A) Firm Price Agreement quotation number E08010377 dated 21st January 2008. Customer Purchase Order number R143828. NPL specimen number R074A was assigned to the Glasgow Caledonian University window.

BASIS OF TEST The NPL Rotatable Wall Guarded Hot Box. Where relevant, the equipment and measurement procedures are in accordance with the requirements of BS EN ISO 8990:1996 and whose calibration is traceable to National Standards. The measurement procedures defined in BS EN ISO 12567-1 was used to measure the window U-value.

UNCERTAINTY The overall measurement uncertainty is estimated to be within $\pm 5.5\%$ based on a standard uncertainty multiplied by a coverage factor $k = 2$, providing a level of confidence of approximately 95 %.

Reference: PP31/E08010377/1

Page 1 of 6

Date of issue: 27th May 2008

Signed:  (Authorised Signatory)

Checked by: 

Name: Ray Williams for Managing Director

NATIONAL PHYSICAL LABORATORY

Continuation Sheet

1 DESCRIPTION OF THE SPECIMEN

Table 1: Window Specifications

NPL Identity Number	R074A
Service Number	PP31/E08010377/1
Window details	
Supplier's name	Glasgow Caledonian University
Customer's description	Traditional wood Sash and Casement single glazed window (as received)
Technical Description	Single glazed - each casement has 6 glazing panels
Frame Material	Wood
Measured Height (m)	1.885
Measured Width (m)	1.067
Outer Frame Thickness (mm)	164.0

A sketch of the window design is shown in Figure 1.

Reference: PP31/E08010377/1

Page 2 of 6

Checked by: *GFB*

NATIONAL PHYSICAL LABORATORY

Continuation Sheet

4 RESULTS

The measurement on R074A was carried out on 29th February 2008

The standardised thermal transmittance value for R074A is given in Table 2, and a summary of the main experimental parameters is given in Table 3.

Table 2: Standardised Thermal Transmittance (U)

NPL Number Customer Identity Frame Material	Environmental Temperature Mean °C	Standardised Thermal Transmittance [2] [3] W/(m ² ·K)
R074A Traditional wood Sash and Casement single glazed window (as received) Wood	11.04	4.5

[2] Corrected for the change in surface resistance that resulted from changing the heat flux density from the value used to establish the air flow conditions that produced a total surface resistance of $0.187 \text{ (m}^2\text{·K)/W}$ ^[See Note 1] with the thin calibration panel, to the heat flux density used when measuring the window.

[3] Rounded to 2 significant figures as required by EN ISO 12567-1.

Reference: PP31/E08010377/1

Page 4 of 6

Checked by: 

NATIONAL PHYSICAL LABORATORY

Continuation Sheet

Table 3: Measurement data for specimen R074A

R074A		
Traditional wood Sash and Casement single glazed window (as received)		
Window dimensions		
Height	1.885	m
Width	1.067	m
Thickness	164.0	mm
Measured values		
Mean warm air temperature	22.41	°C
Mean warm baffle temperature	19.13	°C
Mean cold air temperature	1.46	°C
Mean cold baffle temperature	1.82	°C
Mean cold reveal temperature	2.14	°C
Power to hot box	177.288	W
Air flow rate in the cold box	2.0	m/s
Air flow rate in the hot box	0.3	m/s
Calculated values		
Heat flux density through window*	84.026	W/m ²
Warm side convective fraction*	0.428	
Cold side convective fraction*	0.777	
Warm side environmental temperature*	20.54	°C
Cold side environmental temperature*	1.54	°C
Environmental temperature difference	18.99	°C
Environmental temperature mean	11.04	°C
Measured thermal transmittance (U)	4.42	W/(m ² ·K)
Total surface resistance *	0.190	(m ² ·K)/W
Thermal transmittance (U) standardised ^[2]	4.48	W/m²·K

{*} Values obtained using graphs produced from measurements on the calibration panels.

Reference: PP31/E08010377/1

Page 5 of 6

Checked by: *CTB*

NATIONAL PHYSICAL LABORATORY

Continuation Sheet

Table 3: Measurement data for specimen R074A

R074A		
Traditional wood Sash and Casement single glazed window (as received)		
Window dimensions		
Height	1.885	m
Width	1.067	m
Thickness	164.0	mm
Measured values		
Mean warm air temperature	22.41	°C
Mean warm baffle temperature	19.13	°C
Mean cold air temperature	1.46	°C
Mean cold baffle temperature	1.82	°C
Mean cold reveal temperature	2.14	°C
Power to hot box	177.288	W
Air flow rate in the cold box	2.0	m/s
Air flow rate in the hot box	0.3	m/s
Calculated values		
Heat flux density through window*	84.026	W/m ²
Warm side convective fraction*	0.428	
Cold side convective fraction*	0.777	
Warm side environmental temperature*	20.54	°C
Cold side environmental temperature*	1.54	°C
Environmental temperature difference	18.99	°C
Environmental temperature mean	11.04	°C
Measured thermal transmittance (U)	4.42	W/(m ² ·K)
Total surface resistance *	0.190	(m ² ·K)/W
Thermal transmittance (U) standardised ^[2]	4.48	W/m²·K

{*} Values obtained using graphs produced from measurements on the calibration panels.

NATIONAL PHYSICAL LABORATORY

Continuation Sheet

Figure 1: Window Design

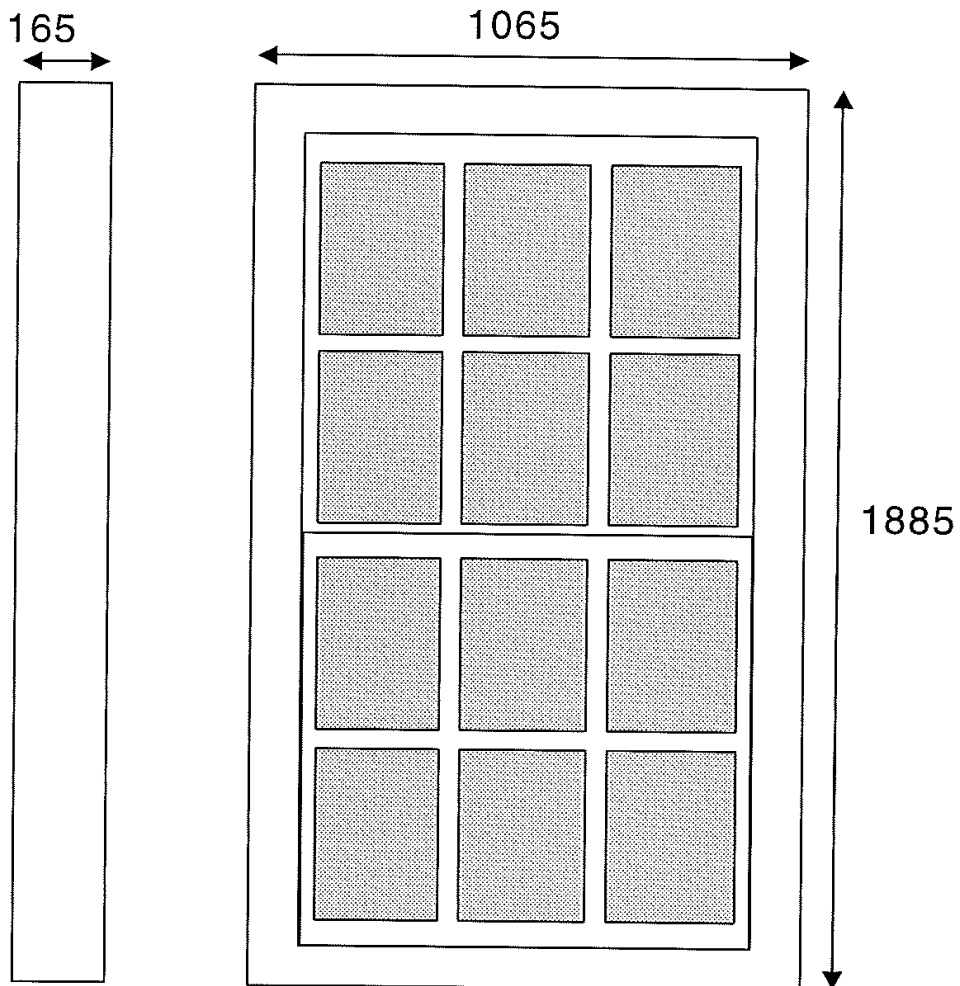

All dimensions in mms

Reference: PP31/E08010377/1

Page 6 of 6

Checked by: *EB*

Appendix 2

NPL Test Report on U-value of sash and casement window after draught proofing

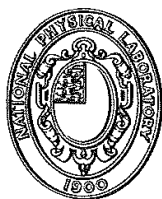

NATIONAL PHYSICAL LABORATORY
Teddington Middlesex UK TW11 0LW Telephone +44 20 8977 3222



Test Report

THERMAL TRANSMITTANCE OF A
Traditional wood sash & casement window - Modified

This test report is issued in accordance with the laboratory accreditation requirements of the United Kingdom Accreditation Service. It provides traceability of measurement to recognised national standards, and to units of measurement realised at the National Physical Laboratory or other recognised national standards laboratories. This test report may not be reproduced other than in full, except with the prior written approval of the issuing laboratory.

FOR
Glasgow Caledonian University
Centre for Research on Indoor Climate & Health
School of Built & Natural Environment
Glasgow Caledonian University
City Campus
Cowcaddens Road
Glasgow
G4 0BA

For the attention of Paul Baker

IDENTIFICATION CSM-4(A) Firm Price Agreement quotation number E08010377 dated 21st January 2008. Customer Purchase Order number R143828. NPL specimen number R074B was assigned to the Glasgow Caledonian University window that had been refurbished by Ventrolla.

BASIS OF TEST The NPL Rotatable Wall Guarded Hot Box. Where relevant, the equipment and measurement procedures are in accordance with the requirements of BS EN ISO 8990:1996 and whose calibration is traceable to National Standards. The measurement procedures defined in BS EN ISO 12567-1 was used to measure the window U-value.

UNCERTAINTY The overall measurement uncertainty is estimated to be within $\pm 5.5\%$ based on a standard uncertainty multiplied by a coverage factor $k = 2$, providing a level of confidence of approximately 95 %

Reference: PP31/E08010377/2

Page 1 of 6

Date of issue: 27th May 2008

Signed:

(Authorised Signatory)

Checked by:

Name:

Ray Williams

for Managing Director

NATIONAL PHYSICAL LABORATORY

Continuation Sheet

1 DESCRIPTION OF THE SPECIMEN

Table 1: Window Specifications

NPL Identity Number	R074B
Service Number	E08010377
Frame Details	
Supplier's name	Glasgow Caledonian University
Customer's description	Traditional wood Sash and Casement single glazed window (Refurbished by Ventrolla as described in Table 1)
Technical Description	Single glazed - each casement has 6 glazing panels
Frame Material	Wood
List of modifications made to R074A by Ventrolla	<ol style="list-style-type: none"> 1) Removed the staff bead from the warm side and the central parting bead. 2) Replaced these with new "U" channel plastic parting bead on the top and sides. 3) Fill space between the new "U" channel and the recess wall with white caulk. 4) Fit new plastic parting bead into "U" channel. 5) Fit new draft proofing "pile number 7" run into new parting bead 6) New single pile carrier (draft proofing) fixed to mid-rail. 7) Fit new single pile carrier with number 8 pile to bottom sash. 8) Fit new locking clamp window catch to central rail. 9) Fit new wood staff beading on the warm side with a new number 8 single pile carrier draft proofing strip all round. 10) Cracks in the warm face of the frame sealed with acrylic mastic. 11) The thermal performance of the sash boxes were improved by dividing them vertically with a plywood panel so isolating the pulley wheels on the warm side from those on the cold side. This reduces the air infiltration through the box sash
Measured Height (m)	1.885
Measured Width (m)	1.067
Outer Frame Thickness (mm)	164.0

A sketch of the window design is shown in Figure 1.

Reference: PP31/E08010377/2

Page 2 of 6

Checked by: 

NATIONAL PHYSICAL LABORATORY

Continuation Sheet

2 THE APPARATUS

Thermal transmittance measurements are made in the NPL Rotatable Wall Guarded Hot Box, described in NPL Report CBTLM 25. Where relevant, the equipment and measurement procedures are in accordance with the requirements of BS EN ISO 8990:1996. The main features of the equipment are summarised below:

- The interior dimensions of the hot box are 2.4 m x 2.4 m.
- All surfaces "seen" by the test element are matt black.
- There are twenty five air temperature sensors, 75 mm from the holder panel face, positioned at the centres of squares of equal areas in front of the window in both the hot and cold boxes.
- The net heat flow direction is horizontal.

3 MEASUREMENT PROCEDURES

The measurement procedures specified in BS EN ISO 12567-1 were used. It is an air-to-air method requiring no surface measurements of the window being tested. The procedure requires a schedule of measurements to be made on two different thicknesses of calibration panels, at three different temperature conditions. The calibration panels comprised a core of expanded polystyrene sandwiched between sheets of 4 mm thick float glass. The thermal conductivity of the expanded polystyrene was measured in the NPL standard guarded hot plate apparatus and the average thickness of the calibration panels was measured. From these data the thermal conductance of each calibration panel was determined.

From the data obtained for the measurements on the calibration panels, three graphs are produced, which are used to carry out the following:

- Calculation of the heat flux density through the holder panel, including any boundary loss around the reveal.
- Calculation of the hot and cold environmental temperatures.
- Correction for the change in surface resistance that results from changing the heat flux density, from the value used to establish the air flow conditions that produced a total surface resistance of $0.187 \text{ (m}^2\cdot\text{K)/W}^{\text{[Note 1]}}$ with the thin calibration panel, to the heat flux density used when measuring the window.

The windows was mounted in a 300 mm thick expanded polystyrene holder panel as specified in BS EN ISO 12567-1, and the measurements carried out at the temperature conditions specified.

Thermal transmittance values quoted are the mean of five sets of readings taken at two-hourly intervals. Equilibrium is assumed when the maximum difference between the five thermal transmittance values is less than 1 %.

Note 1: - BS EN ISO 12567-1 actually requires the initial measurement on the 20 mm glazed calibration panel to produce a total surface resistance of $0.17 \pm 0.02 \text{ m}^2\cdot\text{K/W}$ - but this was not possible with a 300 mm thick surround panel and so it was set to $0.187 \text{ m}^2\cdot\text{K/W}$.

Reference: PP31/E08010377/2

Page 3 of 6

Checked by: 

NATIONAL PHYSICAL LABORATORY

Continuation Sheet

4 RESULTS

The measurement on R074B was carried out on 16th March 2008

The standardised thermal transmittance value for R074B is given in Table 2, and a summary of the main experimental parameters is given in Table 3.

Table 2: Standardised Thermal Transmittance (U)

NPL Number Customer Identity Frame Material	Environmental Temperature Mean °C	Standardised Thermal Transmittance [2] [3] W/(m ² ·K)
R074B Traditional wood Sash and Casement single glazed window (Refurbished by Ventrolla as described in Table 1) Wood	10.96	4.2

[2] Corrected for the change in surface resistance that resulted from changing the heat flux density from the value used to establish the air flow conditions that produced a total surface resistance of $0.187 \text{ (m}^2\cdot\text{K)/W}$ ^[See Note 1] with the thin calibration panel, to the heat flux density used when measuring the window.

[3] Rounded to 2 significant figures as required by EN ISO 12567-1.

Reference: PP31/E08010377/2

Page 4 of 6

Checked by: 

NATIONAL PHYSICAL LABORATORY

Continuation Sheet

Table 3: Measurement Data for Specimen R074B

R074B		
Traditional wood Sash and Casement single glazed window (Refurbished by Ventrolla as described in Table 1)		
Window dimensions		
Height	1.885	m
Width	1.067	m
Thickness	164.0	mm
Measured values		
Mean warm air temperature	22.13	°C
Mean warm baffle temperature	18.89	°C
Mean cold air temperature	1.58	°C
Mean cold baffle temperature	1.92	°C
Mean cold reveal temperature	2.20	°C
Power to hot box	165.405	W
Air flow rate in the cold box	1.9	m/s
Air flow rate in the hot box	0.3	m/s
Calculated values		
Heat flux density through window*	78.198	W/m ²
Warm side convective fraction*	0.423	
Cold side convective fraction*	0.776	
Warm side environmental temperature*	20.26	°C
Cold side environmental temperature*	1.65	°C
Environmental temperature difference	18.61	°C
Environmental temperature mean	10.96	°C
Measured thermal transmittance (U)	4.20	W/(m ² ·K)
Total surface resistance *	0.190	(m ² ·K)/W
Thermal transmittance (U) standardised ^[2]	4.25	W/(m²·K)

{*} Values obtained using graphs produced from measurements on the calibration panels.

Reference: PP31/E08010377/2

Page 5 of 6

Checked by: 

NATIONAL PHYSICAL LABORATORY

Continuation Sheet

Figure 1: Window Design

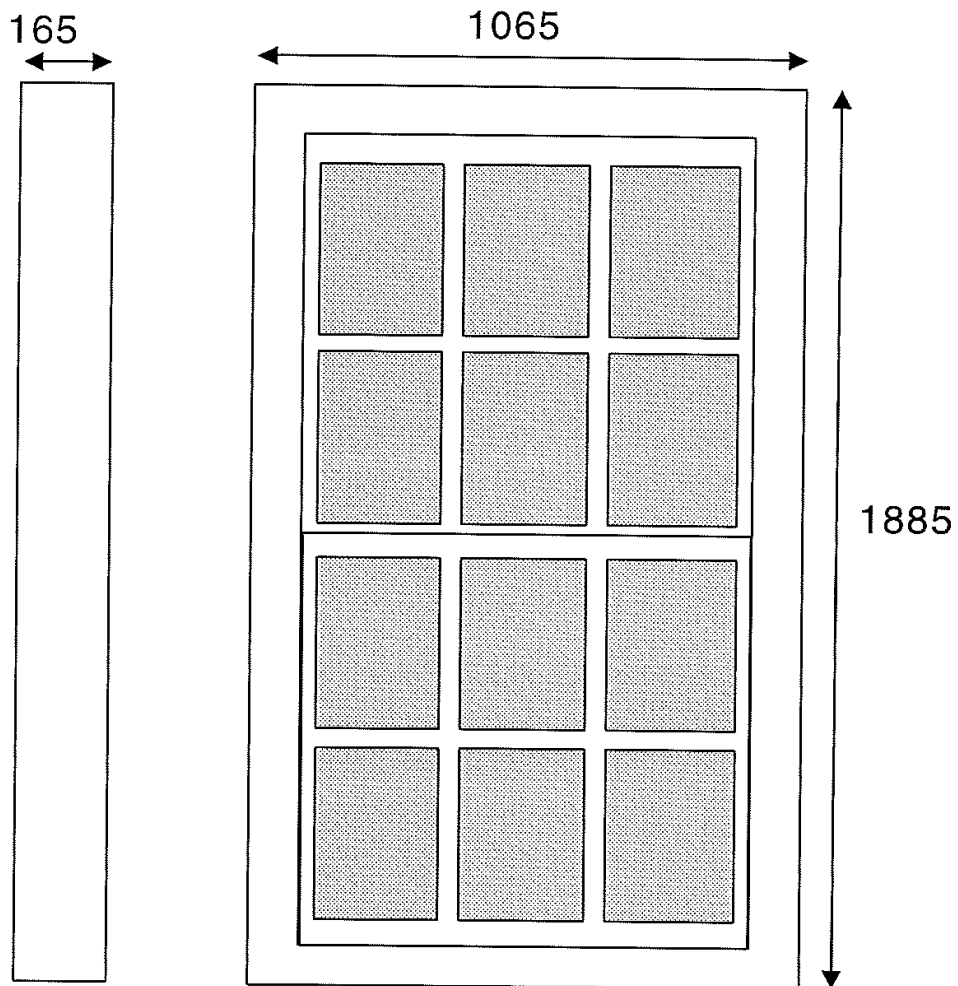

All dimensions in mms

Reference: PP31/E08010377/2

Page 6 of 6

Checked by: *GTB*



**Published by
Technical Conservation Group**

October 2008

with corrections and clarifications, September 2010

Historic Scotland, Longmore House, Salisbury Place, Edinburgh, EH9 1SH

Tel: 0131 668 8600

Publications: 0131 668 8638

Website: www.historic-scotland.gov.uk

Email: hs.technicalconservationgroup@scotland.gsi.gov.uk

© Crown copyright